



INSTALLATION GUIDE: AWE EXHAUST SUITE FOR RAM TRX

For up-to-date fitment information, please visit the product page on [AWE-Tuning.com](https://www.awe-tuning.com).

THIS GUIDE IS INTENDED FOR THE FOLLOWING PART NUMBERS:

- 3015-32004 AWE 0FG Catback Exhaust for RAM TRX - Chrome Silver Tips
- 3015-33005 AWE 0FG Catback Exhaust for RAM TRX - Diamond Black Tips

Welcome to the AWE family, and congratulations on your purchase of the AWE Exhaust System for the RAM TRX.

Exquisite build quality and craftsmanship, coupled with industry leading performance, distinguish this exhaust system from all others.

*For up to the minute fitment information, be sure to visit the AWE website. As always, AWE Performance Specialists are standing by for any questions, [right here](#).

PARTS LIST (OFG SYSTEMS CHROME SILVER TIPS)



Inspect **ALL** parts prior to disassembly of vehicle; If damaged or **MISSING**, please contact the place of purchase immediately.

Symbol	Part Number	Description	QTY
	D96	RAM TRX Driver Inlet	1
	D97	RAM TRX Passenger Inlet	1
	D98	RAM TRX Resonated H Pipe	1
	D99	RAM TRX Driver Mid Pipe	1
	E01	RAM TRX Driver HR5 Section	1
	E02	RAM TRX Passenger HR5 Section	1
	E03	RAM TRX Driver Axle Tube	1
	E04	RAM TRX Passenger Axle Tube	1
	E05	RAM TRX Driver Tail Pipe	1
	E06	RAM TRX Passenger Tail Pipe	1
A >>	390300	3 Inch SS Smart Seal Band Clamp	9
B >>	3528N13	Flange Nut M10 X 1.5	4
C >>	91280A638	Zinc Plated Hex Head Cap Screw, M10 Size, 40mm Length	4
D >>	93475A280	18-8 SS Flat Washer, M10 Screw Size	4
E >>	3910-11012	Clamp-Kit	2
F >>	180006	AWE Tuning Chrome 5" Slash Cut Tip	2
G >>	3910-41010	Hardware Kit for Integrated Clamp Style Exhaust Tips– Quad	1

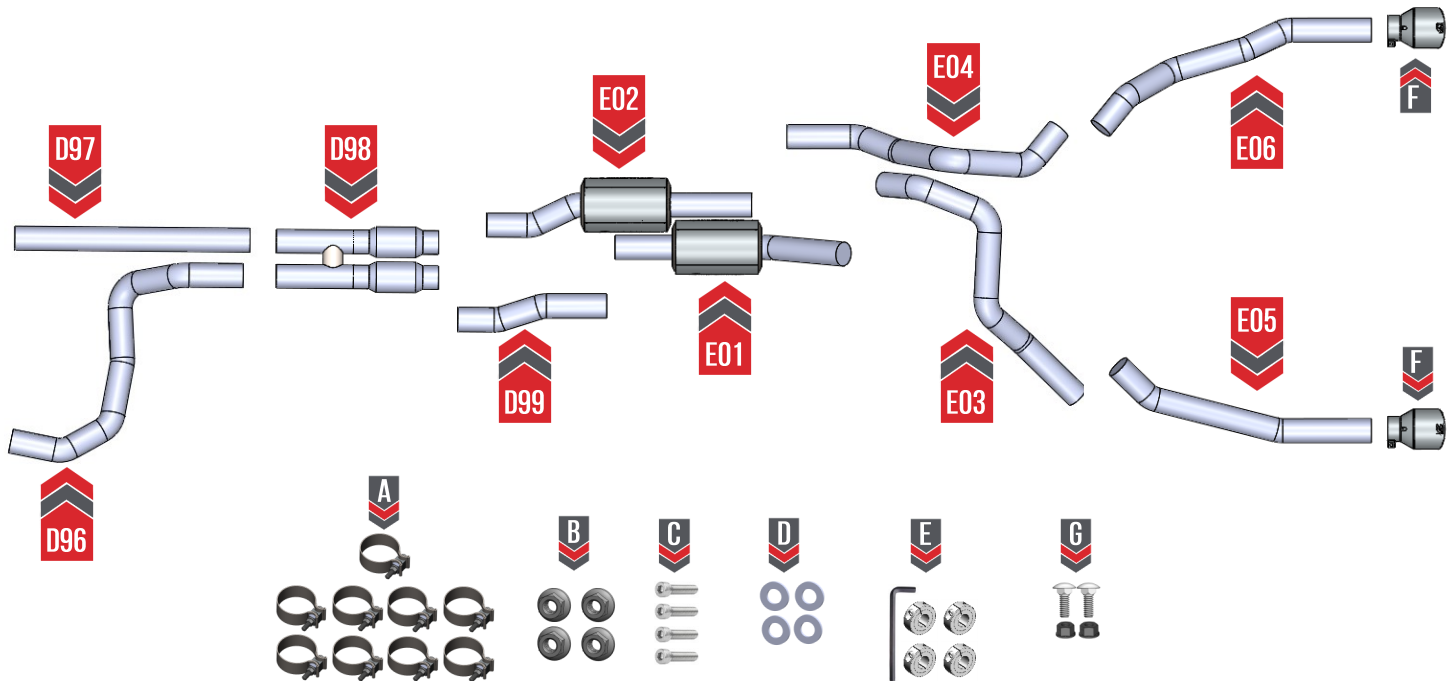

PARTS LIST (OFG SYSTEMS DIAMOND BLACK TIPS)



Inspect **ALL** parts prior to disassembly of vehicle; If damaged or **MISSING**, please contact the place of purchase immediately.

Symbol	Part Number	Description	QTY
	D96	RAM TRX Driver Inlet	1
	D97	RAM TRX Passenger Inlet	1
	D98	RAM TRX Resonated H Pipe	1
	D99	RAM TRX Driver Mid Pipe	1
	E01	RAM TRX Driver HR5 Section	1
	E02	RAM TRX Passenger HR5 Section	1
	E03	RAM TRX Driver Axle Tube	1
	E04	RAM TRX Passenger Axle Tube	1
	E05	RAM TRX Driver Tail Pipe	1
	E06	RAM TRX Passenger Tail Pipe	1
A >>	390300	3 Inch SS Smart Seal Band Clamp	9
B >>	3528N13	Flange Nut M10 X 1.5	4
C >>	91280A638	Zinc Plated Hex Head Cap Screw, M10 Size, 40mm Length	4
D >>	93475A280	18-8 SS Flat Washer, M10 Screw Size	4
E >>	3910-11012	Clamp-Kit	2
H >>	180007	AWE Tuning Black Chrome 5" Slash Cut Tip	2
G >>	3910-41010	Hardware Kit for Integrated Clamp Style Exhaust Tips– Quad	1

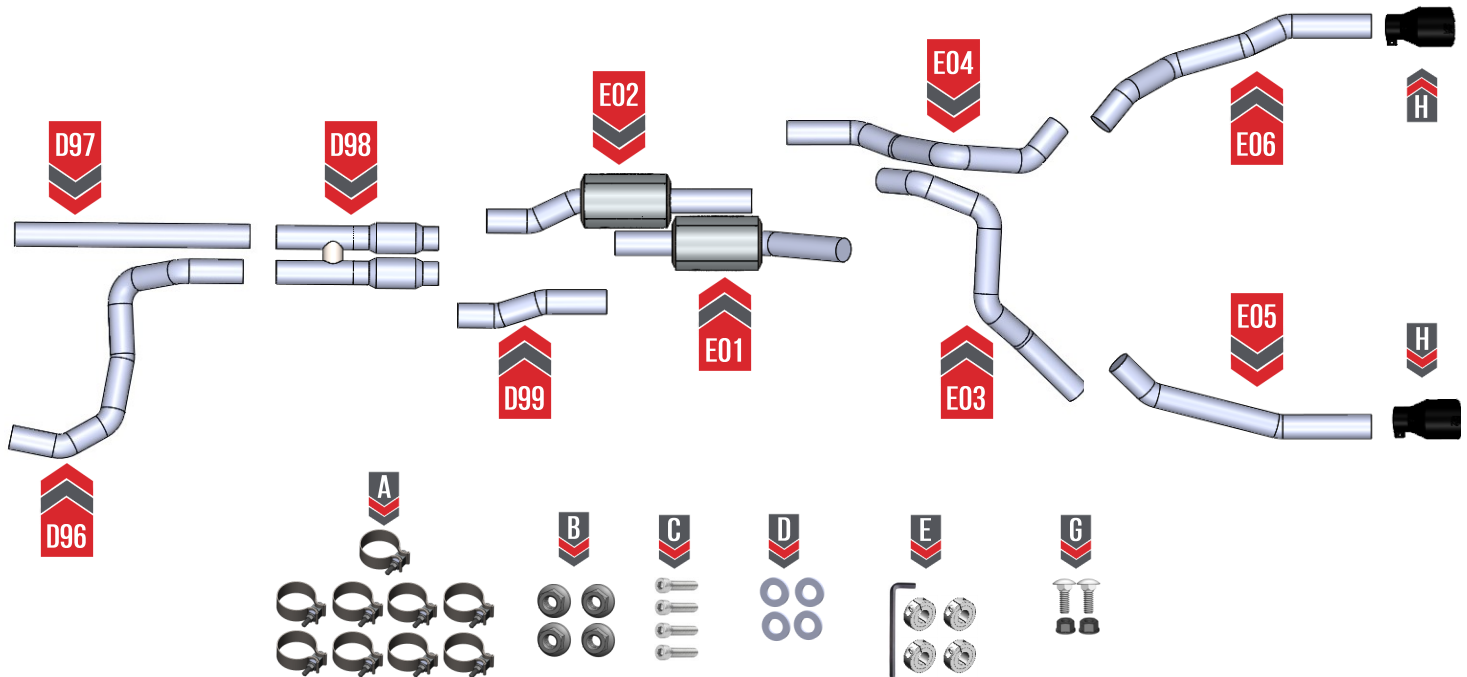



NOTE: Always refer to the manufacturer's service manual for precise torque specifications on all OEM fasteners.



CAUTION: The exhaust may be **VERY HOT** — allow adequate time for the system to cool down before disassembly. Severe burns and injury will occur if skin comes into contact with a hot exhaust system.



NOTE: This is a large system to remove and install. We highly recommend you grab a friend to help out with the entire process.

STEP 1

To start lift your vehicle off the ground. For a successful installation it is important that the rear suspension is at full droop.

STEP 2

Begin by removing the OE skid plate (A), as shown in **Figure 2**. This is done by removing the bolts marked by the red arrows (B).

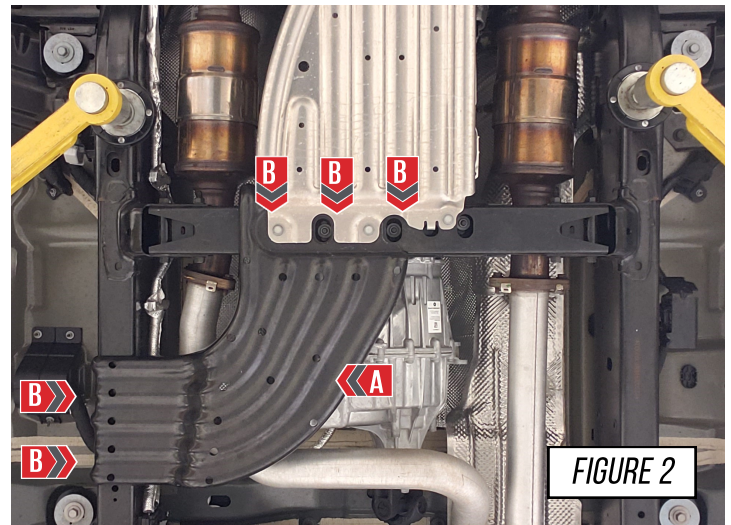

FIGURE 2

STEP 3

Unbolt the center shock on the rear end, as shown in **Figure 3**.

Lift the shock up towards the body of the truck. This gives you proper clearance to remove the factory system, and to install your AWE system.



Note: Wrapping a cloth or rag around the rear end center shock, will help prevent damage to the shock from the OE exhaust removal.

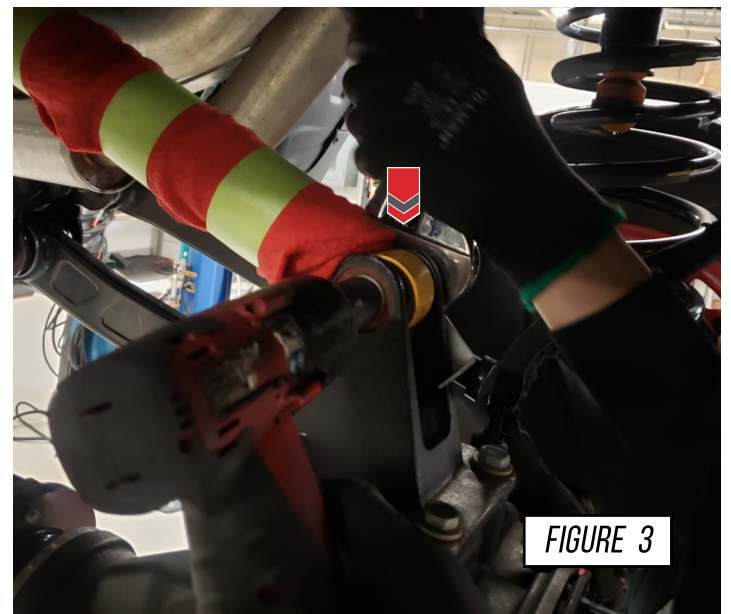
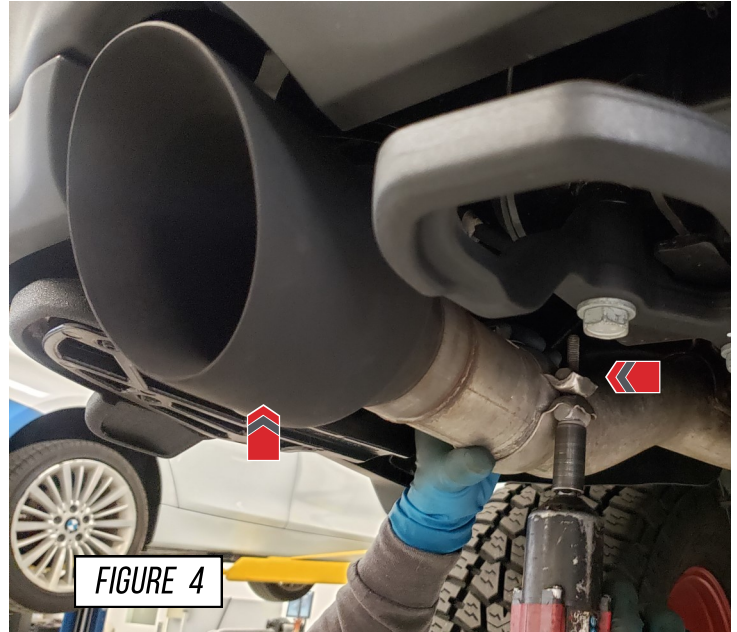

FIGURE 3

STEP 4

Remove the OE tip sections from the driver and passenger side of the vehicle, as shown in **Figure 4**.



STEP 5

Loosen the clamp on the OE passenger side tailpipe (**A**) as shown in **Figure 5-1**.

Slide the clamp off the slip joint (**B**) shown in **Figure 5-2**.

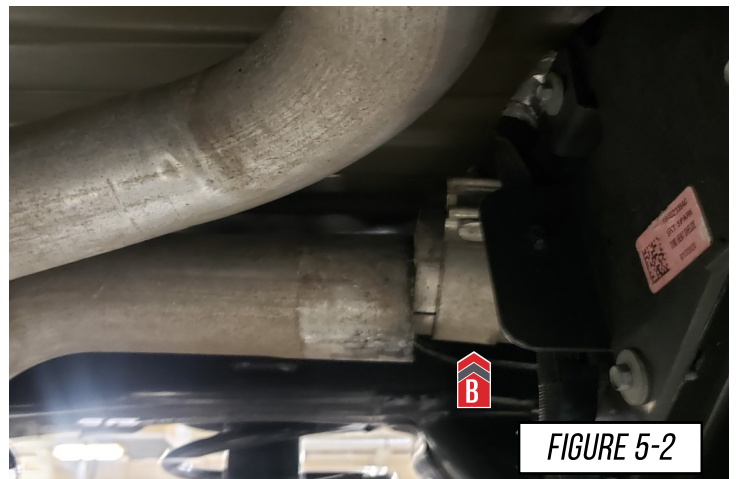

STEP 6

Remove the OE rubber exhaust mount (A), as shown in **Figure 6**.

This will allow you to fully remove the passenger side tailpipe section (B).

 **Note:** Soak all hangers in lubricant for easier removal.

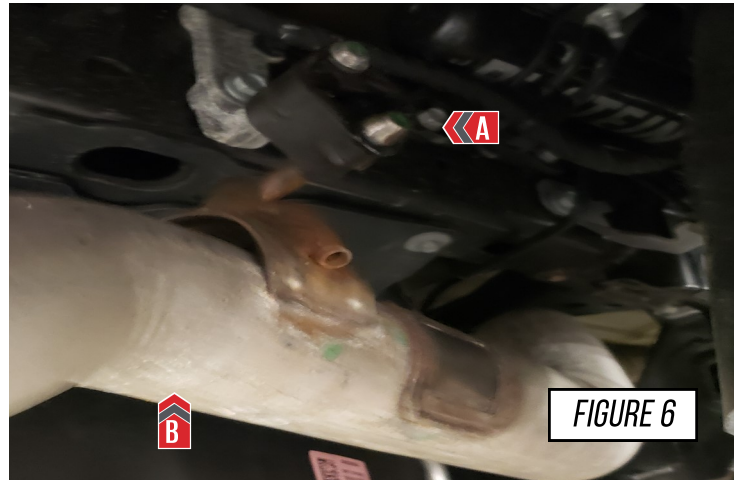

STEP 7

Remove the OE rubber Exhaust hanger (A) from behind the X-pipe, shown in **Figure 7-1**.

Then remove the exhaust hanger from behind the resonators section (B) of the OE exhaust, shown in **Figure 7-2**.

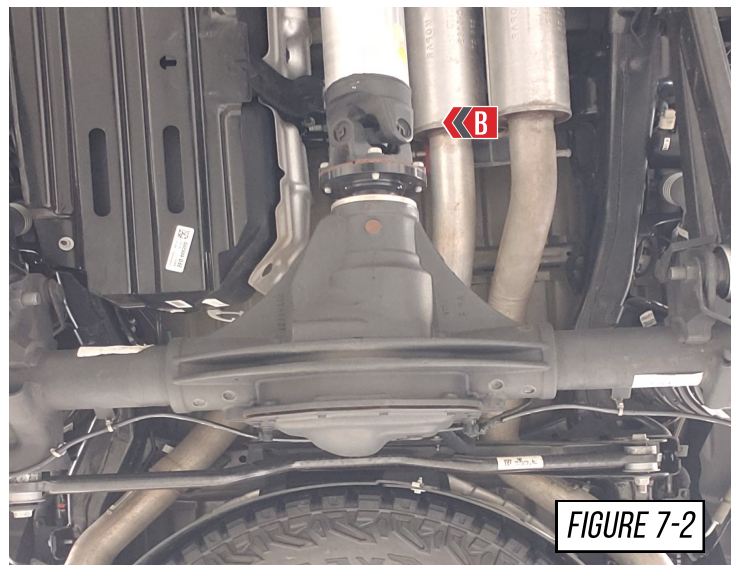
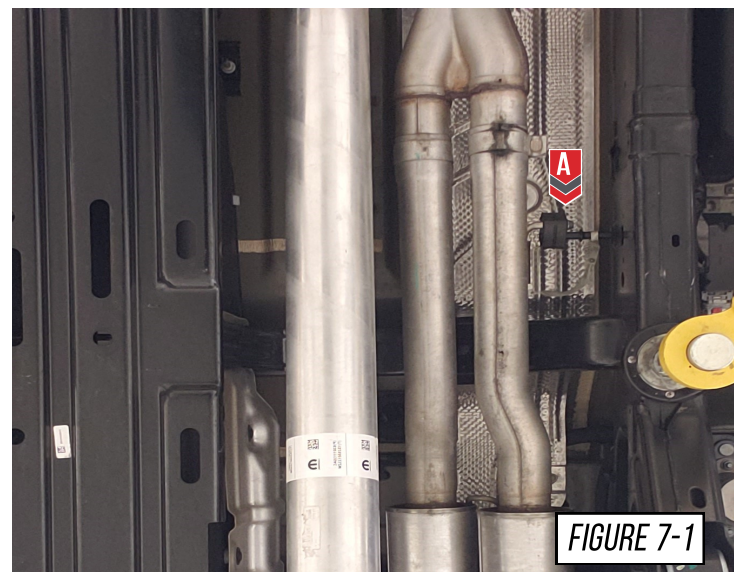

STEP 8

Remove the OE rubber hanger on the drivers side tailpipe (A) as shown in **Figure 8-1**.

Next remove the ground strap (B) from the hanger behind the OE X-pipe, as shown in **Figure 8-2**.

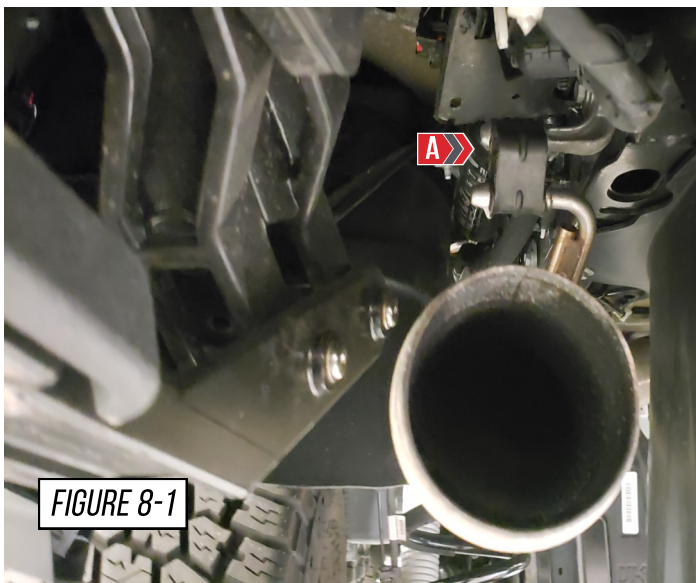

STEP 9

Next the OE clamps need to be loosened and slid off the OE resonator section behind the OE X-pipe, as shown in **Figure 9**.

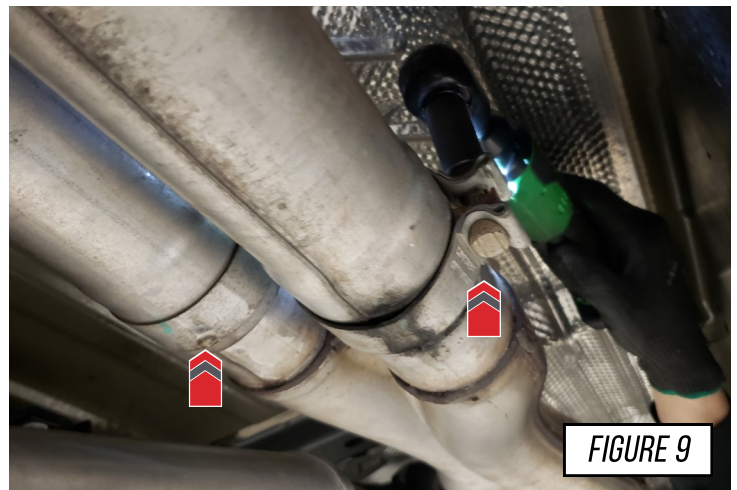

STEP 10

Slide the factory resonator section off of the X-pipe outlet side. A rubber mallet may be needed to tap the resonators, as shown in **Figure 10**. This will make room for the removal of the factory inlet section, and X-pipe.



STEP 11

Remove the drivers side bolts shown at (A), and the passenger side bolts shown at (B), in **Figure 11**.



Note: Have a friend hold the inlet section up as you remove the bolts. Once the bolts are removed the factory inlet section and X-pipe will rest on the chassis brace beneath the X-pipe.

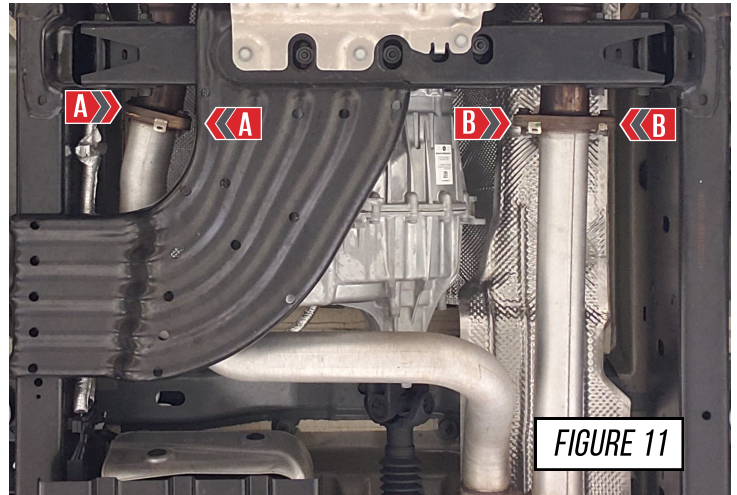

STEP 12

Remove the factory inlet section, and X-pipe by Sliding the tubes toward the Rear of the truck, then angling the front end of the tubes towards the ground, as shown in **Figure 12**. Then pull the tubes out from above the chassis brace (**A**).

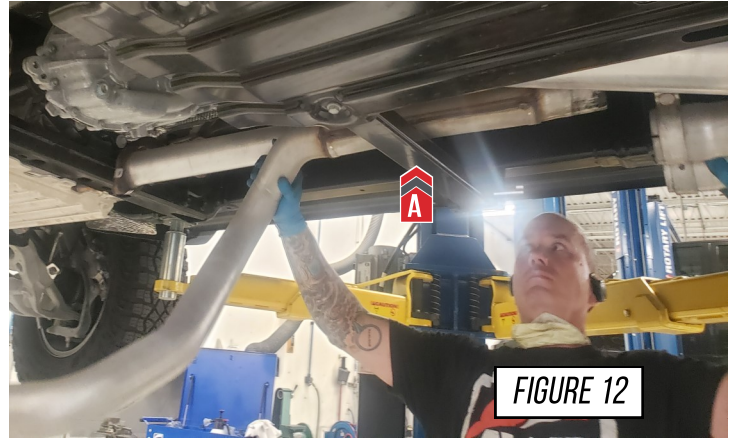

STEP 13

Remove the factory resonator section. To do this you must pull the entire piece down, and towards the front of the truck, as shown in **Figure 13**.

 **Note:** Be careful of clearance around the rear axle, and the rear axle shock.

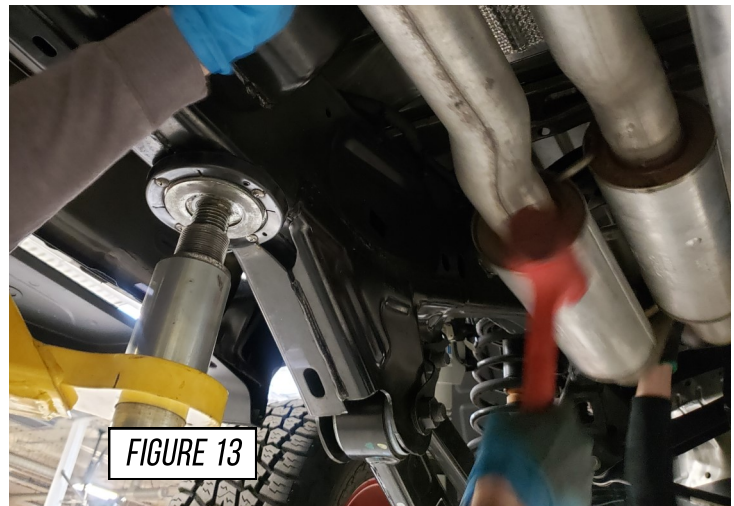

STEP 14

Before installing your AWE inlet sections, make sure to put the provided M10 bolts through the flange as shown at (**A**) in **Figure 14**.

 **Note:** The factory gaskets will be reused.

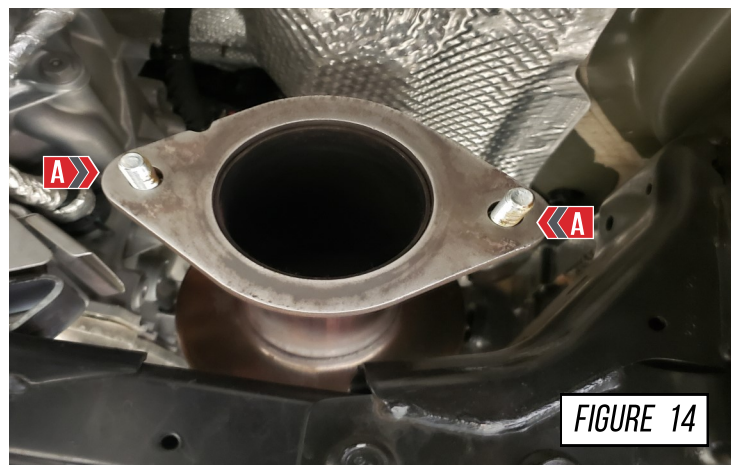

STEP 15

Now install your AWE inlet sections, making sure that the tooth (A) on the flanges of both pipes are facing down from the body of the truck.

Snug the flange in place using the provided hardware (B), as shown in **Figure 15**.

 **Note:** Snug the bolts to allow adjustment later.

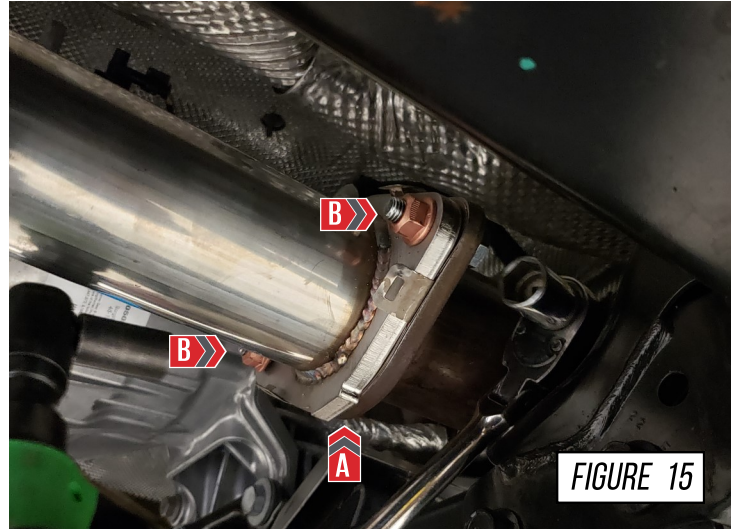

STEP 16

Slide a clamp on each end of the 2 AWE inlet sections.

Now put your AWE resonated H-pipe into place over the chassis brace for proper alignments, as shown in **Figure 16**.

Note: If you are unable to get the H-pipe into this position you will need to loose the ball flange on the front side of the catalytic converters. This will allow you to position the H-pipe correctly. Once desired fitment is achieved tighten the flanges on the catalytic converters.

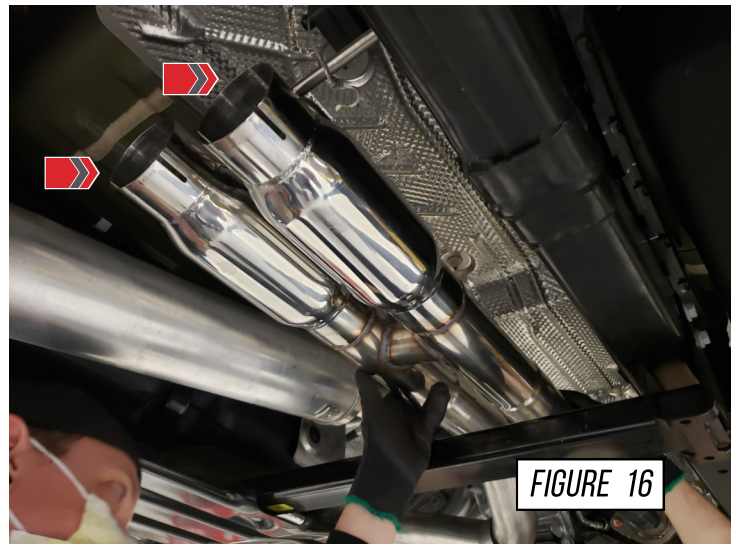

STEP 17

When installing your AWE resonated H-pipe, you want to position the hanger bar on the H-pipe parallel and slightly in front of the hanger bar on the frame of the truck, as shown in **Figure 17**

 The positioning of the H-pipe hanger is extremely important for the final alignment of the entire system.

Note: Picture is taken looking up from ground, with the top of the photo being toward the rear of the truck.

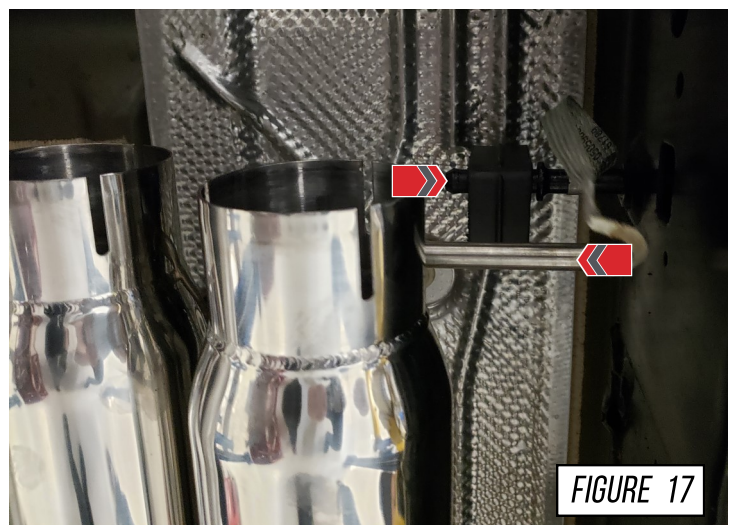

STEP 18

Once the H-pipe is in proper position, tighten the two clamps at the inlet of the H-pipe then tighten the bolts on the inlet flanges.

Re-attach the ground strap to the H-pipe hanger bar as shown in **Figure 18**



FIGURE 18

STEP 19

Slide a hanger over each side of the H-pipe outlets. For ease of installation, position the clamps with the bolt head facing the drive shaft, as shown at (A) in **Figure 19**.

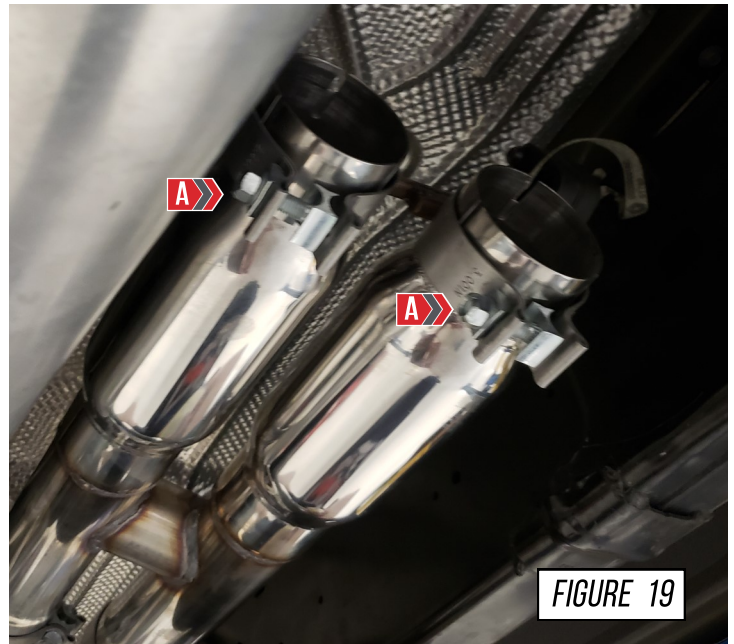

FIGURE 19

STEP 20

Measure 1 7/8" and mark on the short end of your AWE driver side mid pipe (D99), as shown in **Figure 20**, and the short end of your AWE passenger side HR5 section (E02). This will be the full slip depth that these two tubes go into the AWE resonated H-pipe.



IT IS CRUCIAL TO MEASURE 1 7/8" on both your AWE driver side mid pipe (D99), and your AWE passenger side HR5 section (E02). The correct slip depth is extremely important for proper alignment, and fitment of the system.

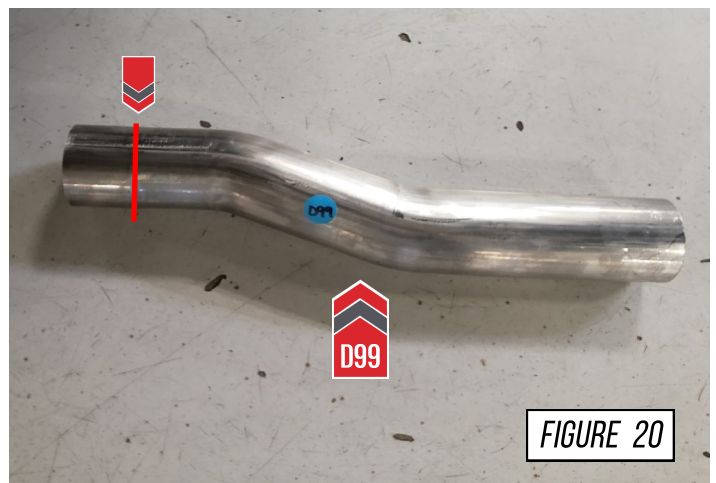

FIGURE 20

STEP 21

Install your AWE driver side mid pipe (**D99**) and passenger side HR5 section (**E02**)

It is very important to position your AWE driver side mid pipe (**D99**) as shown at **(A)** in **Figure 21**. Position the bend pointing upwards towards the underside of the truck body.

Position your AWE passenger side HR5 section, as shown at **(B)** in **Figure 21**.

Lastly slide a clamp over the end of the AWE driver side mid pipe (**D99**).

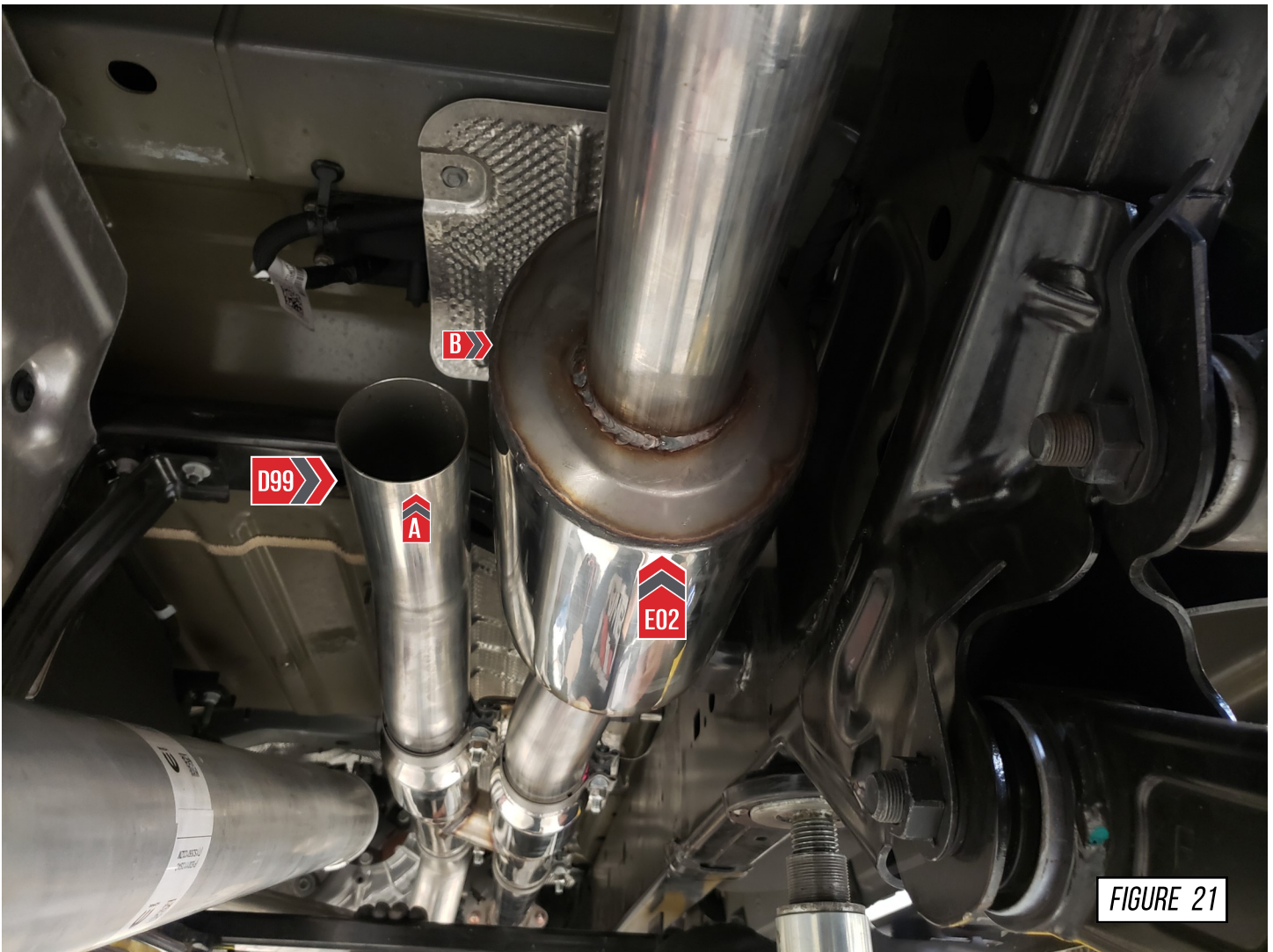
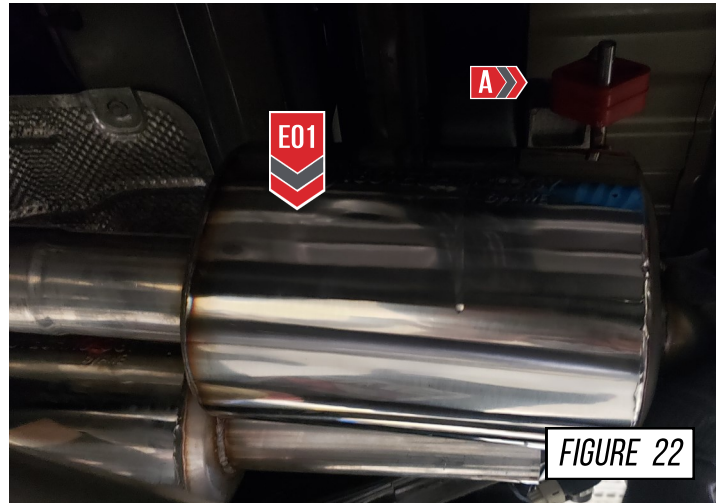

FIGURE 21

STEP 22

Insert the hanger bar on the AWE driver side HR5 section (**E01**) into hanger on the truck (**A**), as shown in **Figure 22**.

Next slide the HR5 section into place by bottoming it out on the AWE driver side mid pipe.



STEP 23

Position the AWE sections (**E01**) and (**E02**) so the HR5 cans are vertical, and aligned with each other as shown in **Figure 23**.

There should be clearance between the faces (**A**) of each can so they do not touch each other. Additionally it is important that there is a half inch of clearance between **E02** and the frame rail (**B**).

Once this clearance is achieved, snug the clams. Do not tighten fully to allow for adjustments later.

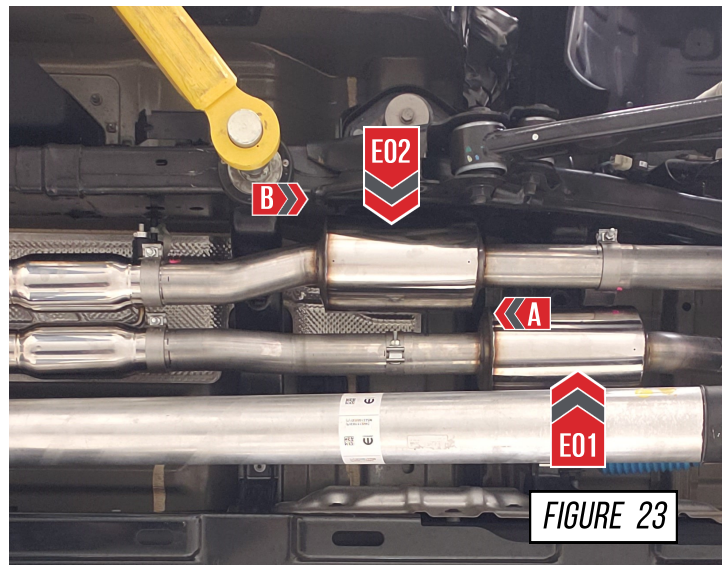

**THE TUBE POSITION IN STEPS 21-23 IS CRUCIAL FOR PROPER FITMENT.
PLEASE DOUBLE CHECK POSITIONING BEFORE MOVING FORWARD.**



STEP 24

Slide a clamp over the outlet of your AWE passenger side HR5 section (**E02**).

Next install your AWE passenger side axle tube (**E04**). To do this position the tube in the hole in the frame as shown in **Figure 24**.

 **Note:** Once aligned in the frame hole, snug the clamp down. Do not fully tighten to allow for adjustment later.

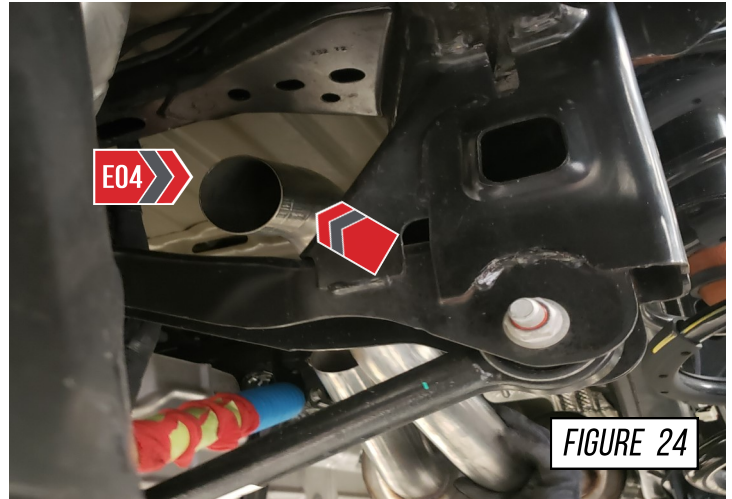

STEP 25

Slide a clamp over the outlet of the AWE driver side HR5 section (**E01**).

Install the AWE driver side axle tube (**E03**) as shown in **Figure 25**.

 **Note:** When installing the AWE driver side axle tube be careful not to damage the rear end shock (**A**) in **Figure 25**.

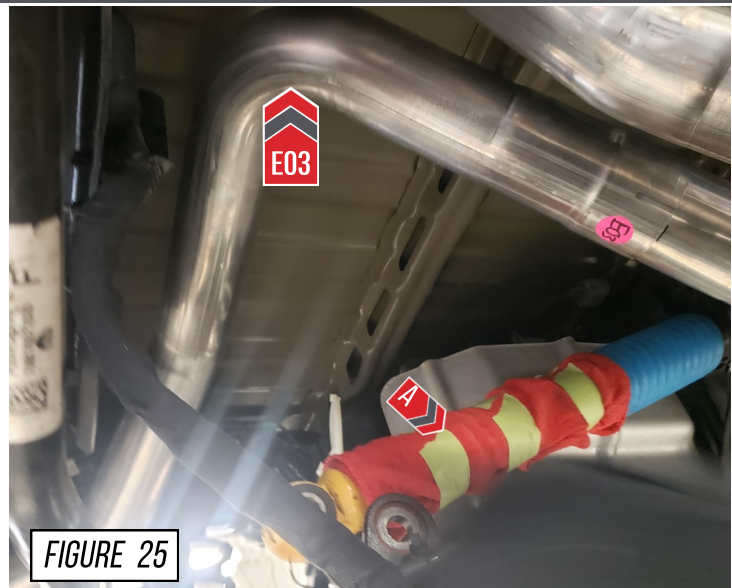

STEP 26

Before installing your AWE tail pipe sections (**E05**) and (**E06**) install a lock collar on the inner side of the hanger bar on each tube, as shown at (**A**) in **Figure 26**.

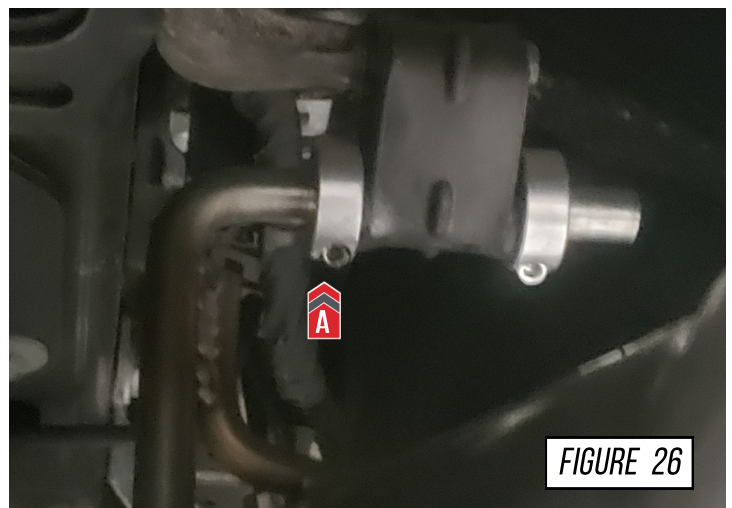

STEP 27

Install your AWE driver side tail pipe (E05). To do this you have to simultaneously line up the slip with (E03) joint located at (A) while inserting the AWE hanger bar onto the OE rubber hanger mount (B) in **Figure 27**.

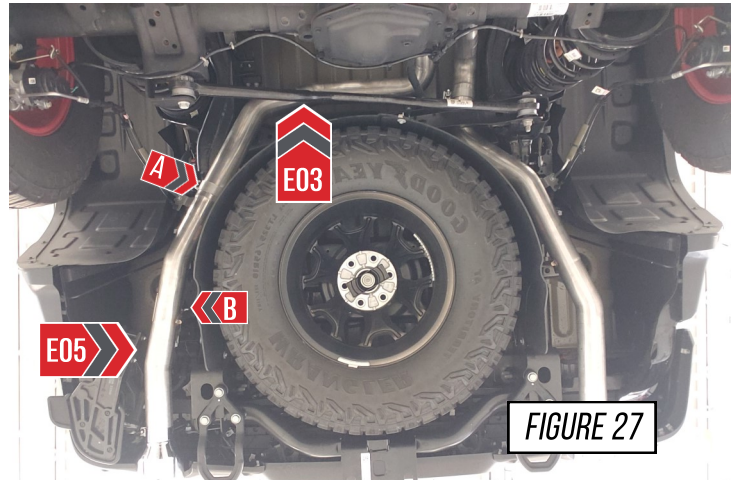

STEP 28

Begin installing your AWE passenger side tail pipe (E06) by inserting the AWE hanger bar into the OE rubber mount, as shown in **Figure 28**.

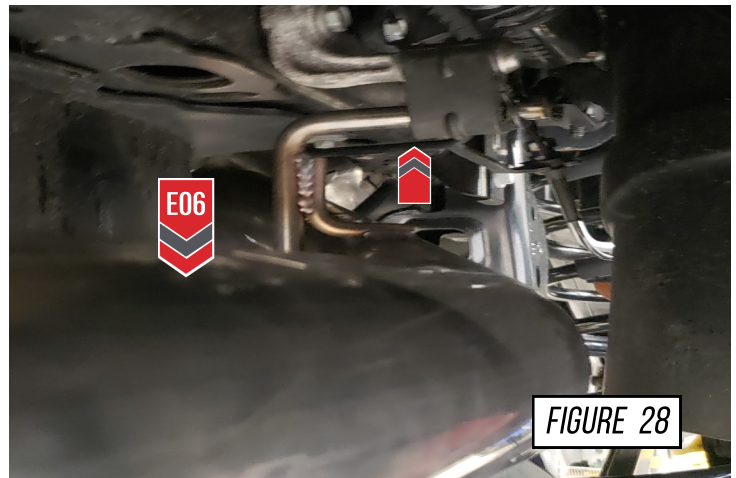

STEP 29

To finish installing the AWE passenger side tail pipe (E06), align the expanded end of the tail pipe with the AWE passenger side axle (E04).

Then bottom out the slip joint between the two pipes, as shown in **Figure 29**.

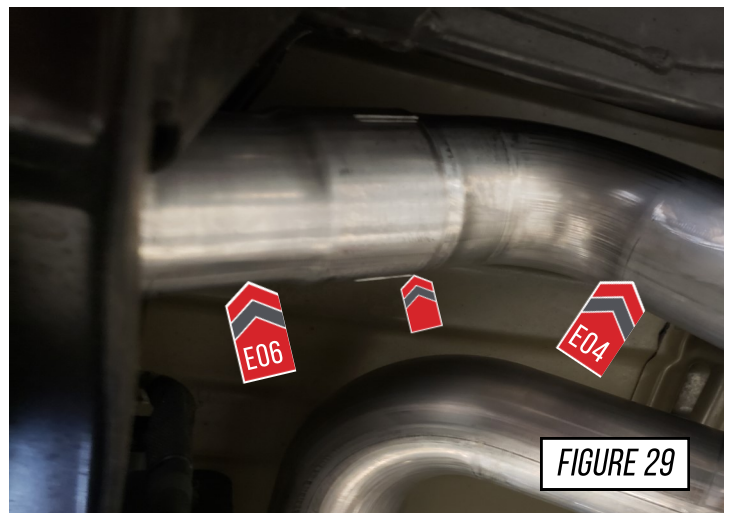

STEP 30

It is crucial to install each section and exhaust band clamps correctly to prevent loose joints, exhaust leaks and rattles.

Arrow A shows the expanded pipe and the preinstalled exhaust clamp being brought up to the corresponding pipe.

Arrow B shows the overlapping pipe installed correctly over the corresponding pipe.

Arrow C shows the exhaust band clamp being brought to the edge of the expanded pipe.



NOTES:

- **Do not** fully torque any exhaust clamp until the entire exhaust has been installed and adjusted.
- Torque specification is a **minimum** of 60 ft/lbs

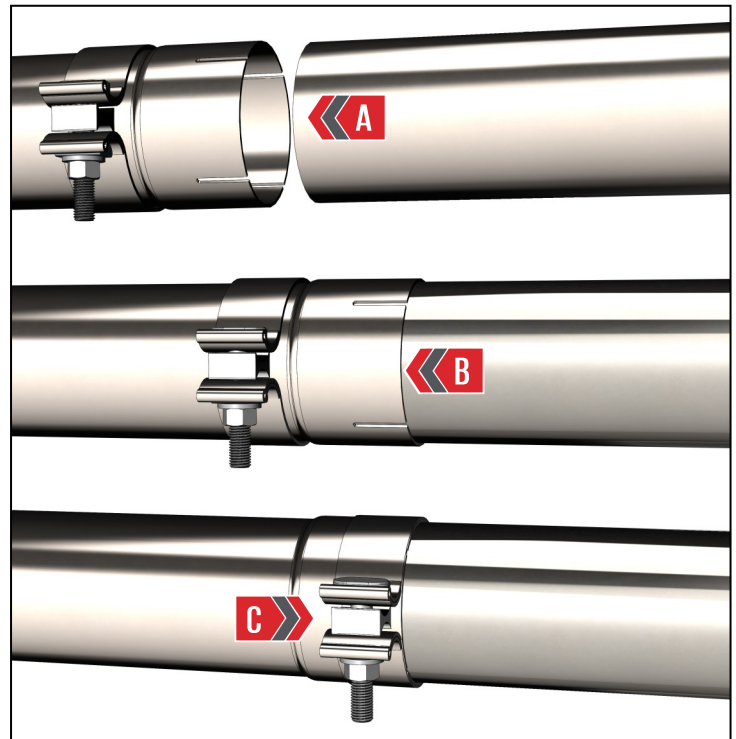

STEP 31

Install the tips onto the driver and passenger tail pipes, as shown in **Figure 31**.

Snug the clamps onto the tail pipes to allow for adjustment.



FIGURE 31

STEP 32

To install the exhaust tips with integrated clamps, first, attach the exhaust tip in the proper orientation onto the exhaust outlet tube.

Insert one of the carriage bolts from the hardware kit (**3910-41010**) through the tab on the exhaust tip and thread on one of the corresponding nuts.

Using anti-seize on the bolt threads will help installation and prevent breakage of hardware.



This exhaust system only has 2 exhaust tips while the integrated clamp kit has enough hardware for our 4 tip exhaust systems. You will have 2 sets of hardware left over that will not be used.

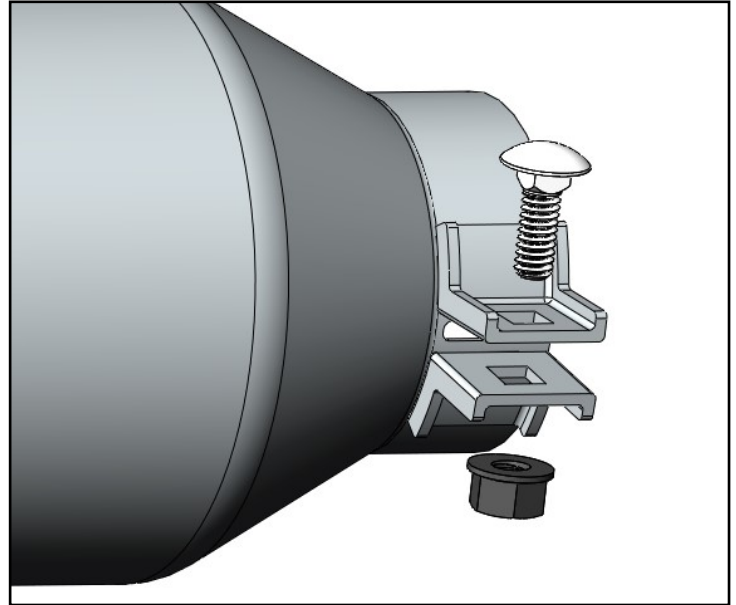

STEP 33

When making final adjustments for tip location, have 1 person hold the tip in desired location, while another person tightens all of the clamps down fully, as shown in **Figure 33**.

Start by tightening clamps at the front of the vehicle. Continue moving towards the back of the vehicle, and make sure the desired fitment stays as each clamp is tightened. Making adjustments accordingly.



FIGURE 33

STEP 34

Install the remaining 2 lock collars onto the outside of each tail pipe hanger bar, as shown in **Figure 34**.

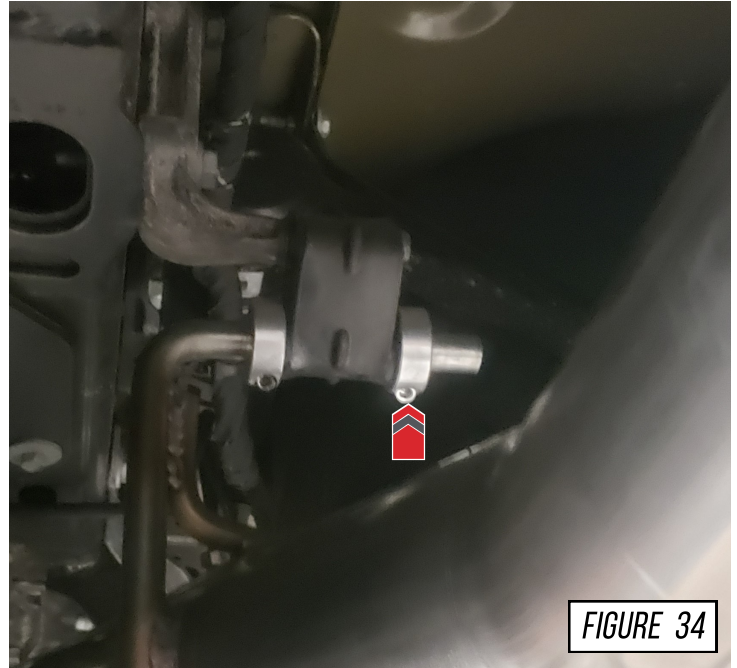

FIGURE 34

STEP 35

Reinstall the rear axle shock. It is necessary to have two people do this step to help compress the shock to get it back into place and aligned.

It is helpful to use a pry bar to compress the shock for alignment, shown in **Figure 34**. Once the holes are lined up insert the factory bolt and fully tighten the nut and bolt.



NOTE: To prevent damage to the shock bushing it is recommended that the bolt is fully tightened once the truck is on the ground.



FIGURE 34

ENJOY!



TROUBLESHOOTING

Issue	Solution
Exhaust is not fitting correctly	Most fitment issues are due to improperly adjusted exhaust. This includes tip fitments and rattling due to chassis contact. Check out our fitment guide for more installation tips.
Wrong or missing parts	Double check the parts list for your system and compare them with what you received. Fill out our contact form, found below and let us know what parts you need.

CARE

Once installed properly, your AWE exhaust will provide years of trouble-free performance.

The exhaust volume and sound will settle with usage; 800-1000 miles is required to break-in new exhaust systems.

Also, please note that the rear **180Technology®** resonator has a small drain hole to allow condensation to escape. Water drops from this area are normal.

Periodic cleaning of exhaust tips is necessary to maintain proper finish, especially in areas prone to road salt and caustic deicing solutions. Use a mild soap and water solution or car wax to clean the finish. Avoid using abrasive polishes, as they can scratch the finish.

Any questions or comments,
please do not hesitate to contact us:

AWE
199 Precision Drive
Horsham, PA 19044
215-658-1670
[CONTACT FORM](#)

WARRANTY

Up-to-date warranty information is found [HERE](#).